

MEDIUM SIZE ERGONOMIC GRIP

## G3-M CONTROL GRIP



G3-M grip with G2 style faceplate

G3-M grip with J2 style faceplate customized with Large FNR K1S

G3-M grip with G2 style faceplate customized with HWTS

The G3-M is a medium sized, ergonomic, modular and customizable grip handle. This handle offers comfort, flexibility, and robust-ness for a multitude of operator control applications. The design of the G3-M is slightly smaller than the G3-C and offers ruggedness, while providing essential control solutions, in a smaller package. The feel of the new design accommodates operators with or without gloves without sacrificing comfort. The G3-M also incorporates a large offering of standard faceplates that can be oriented from 0, 90 and 180 degrees. These faceplates utilize a variety of OTTO's push-buttons, rockers and Hall effect products. The faceplate can also be custom configured with various OTTO switches based on the application requirements. In addition, the G3-M offers an optional trigger integrated in the grip handle.

The G3-M can be panel mounted as a fixed control grip or it can be mounted on an OTTO JH, JHL and JHM joystick. Combining the grip handle with a full featured OTTO joystick base results in an integrated, rugged, and reliable operator control solution. When combined with the JHL joystick, we also offer a bent shaft option to angle the grip 0, 5, 10 or 15 degrees from vertical.

### Features:

- High performance grip in a smaller package
- Can be used with either the left or right hand
- Numerous standard faceplate design options
- Custom faceplate designs available
- Available with or without trigger
- Various mounting and termination styles available
- Modular design provides high level of customization and reduces the need for tooling charges
- Compatible with OTTO JH, JHL and JHM series Hall effect Joysticks
- Accommodates a wide variety of OTTO pushbutton, rockers, toggles, and Hall effect switches

## G3-M DRAWINGS

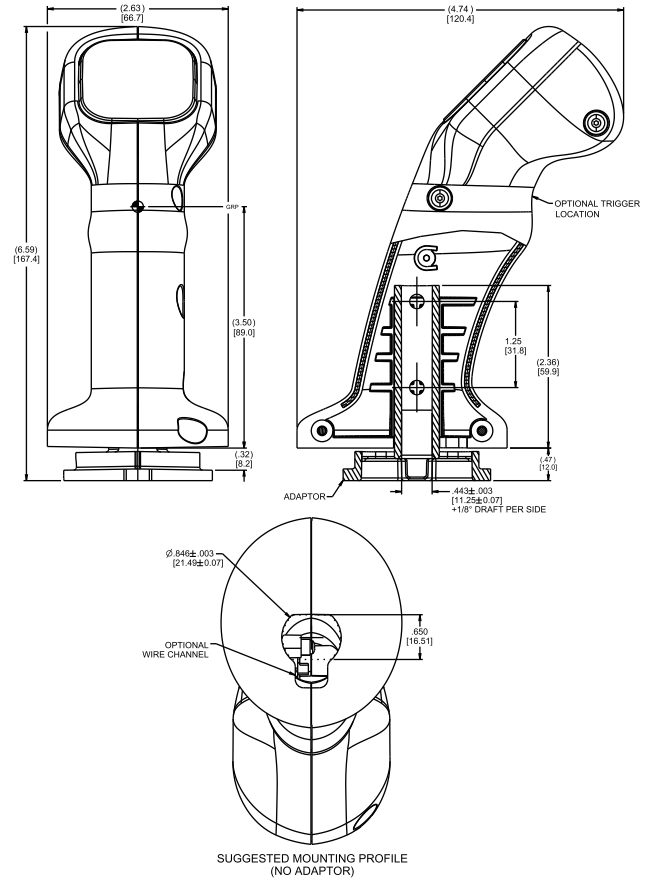

## TRIGGER CONFIGURATIONS

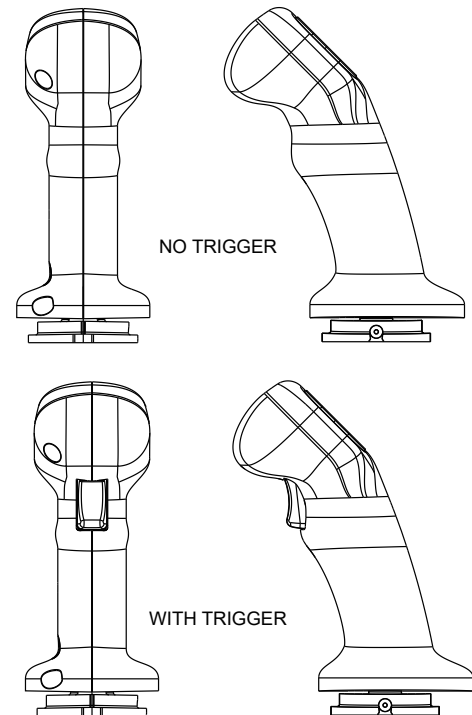

## MEDIUM SIZE ERGONOMIC GRIP

Standard Characteristics/Ratings:				
<b>ELECTRICAL RATINGS</b>				
<b>HTLT4 Switches</b>				
Rated at Vcc = 5V @ 20°C LOAD = 1ma (4.7KΩ)	<b>Units</b>	<b>Min</b>	<b>Typ</b>	<b>Max</b>
Supply Voltage	VDC	4.50	5.00	5.50
Output Voltage, +Y, -Y, +X, -X; 0° Deflection	VDC @5V Vcc	2.25	2.50	2.75
Output At Full Travel -X, -Y Direction	VDC @5V Vcc	0.25	0.50	0.75
Output At Full Travel +X, +Y Direction	VDC @5V Vcc	4.25	4.50	4.75
Supply Current B=0, Vcc=5v, Iout=0	mA	NA	10	12
Output Impedance	Ω	NA	1.0	NA
<b>HTWM Switches</b>				
Rated at Vcc = 5V @ 25°C LOAD = 1ma (4.7KΩ)	<b>Units</b>	<b>Min</b>	<b>Typ</b>	<b>Max</b>
Supply Voltage	VDC	4.50	5.00	5.50
Output Voltage at Center	VDC @5V Vcc	2.25	2.50	2.75
Output Voltage Full Travel Direction 1 (+ Travel)	VDC @5V Vcc	4.25	4.50	4.55
Output Voltage Full Travel Direction 1 (- Travel)	VDC @5V Vcc	0.45	0.50	0.75
Supply Current B=0, Vcc=5v, Iout=0	mA	NA	NA	10
<b>HTWS Switches</b>				
Rated at Vcc = 5V @ 25°C LOAD = 1ma (4.7KΩ)	<b>Units</b>	<b>Min</b>	<b>Typ</b>	<b>Max</b>
Supply Voltage	VDC	4.50	5.00	5.50
Output Voltage at Center	VDC @5V Vcc	2.25	2.50	2.75
Output Voltage Full Travel Direction 1 (+ Travel)	VDC @5V Vcc	4.25	4.50	4.75
Output Voltage Full Travel Direction 1 (- Travel)	VDC @5V Vcc	0.25	0.50	0.75
Supply Current B=0, Vcc=5v, Iout=0	mA	NA	NA	20
<b>K1S Switches</b>				
Electrical Rating	Logic Level, 10 mA @ 5VDC max (logic level ratings void if logic level load(s) exceeded at any time.)			
Electrical Life	1,000,000 Cycles			
<b>P9 Switches &amp; Trigger</b>				
Electrical Rating	5 AMP Resistive Load @ 28 VDC 2 AMP Inductive Load @ 28 VDC		10 mA Resistive Load @ 5 VDC	
Electrical Life	25,000 Cycles		1,250,000 Cycles	

Standard Characteristics/Ratings:				
<b>MECHANICAL RATINGS</b>				
<b>HTLT4 Switches*</b>				
Mechanical Life - Return to Center; Full Forward To Full Back		3,000,000 Cycles		
<b>HTWM Switches*</b>				
Mechanical Life - Return to Center; Full Forward To Full Back		3,000,000 Cycles		
<b>HTWS Switches*</b>				
Mechanical Life - Full Forward To Full Back		3,000,000 Cycles		
Maximum Allowable Radial Load	LBS	NA	NA	15
<b>K1S Switches</b>				
Mechanical Life		1,000,000 Cycles		
<b>P9 Switches &amp; Trigger</b>				
Mechanical Life		1,250,000 Cycles		
<b>ENVIRONMENTAL</b>				
Operating Temperature	°C	-40	20	85
<b>HTLT4 Switches</b>				
Electronic Enclosure Design	ISO 20653, IP6K8S - Dusttight, continuous immersion, 1 meter for 31 minutes, stationary during test(s)			
<b>HTWM Switches</b>				
Electronic Enclosure Design	ISO 20653, IP6K8S - Dusttight, continuous immersion, 1 meter for 31 minutes, stationary during test(s)			
<b>HTWS Switches</b>				
Electronic Enclosure Design	ISO 20653, IP6K8S - Dusttight, continuous immersion, 1 meter for 31 minutes, stationary during test(s)			
<b>K1S Switches</b>				
Electronic Enclosure Design	ISO 20653, IP66/IPK8S - Dusttight, continuous immersion, 1 meter for 31 minutes, stationary during test(s)			
<b>P9 Switches &amp; Trigger</b>				
Switch Seal Integrity	ISO 20653, IP6K8S, IP69K - Dusttight, continuous immersion, 1 meter for 31 minutes, stationary during test(s)			
<b>Grip</b>				
Seal Integrity	Unsealed			
<b>MATERIAL</b>				
Handle	Thermoplastic, Glass Reinforced, Black			
Faceplate	Thermoplastic, Glass Reinforced, Black			
Adaptor	Thermoplastic, Glass Reinforced, Black			
Wires	22AWG, UL style 1569, (20" long)			

\* Positive travel is up or to the right. Contact factory for additional options.

### G3-M PART NUMBER CODE

G3-M	X	XX	X	X	X	X	X	X
Configuration	Faceplate	Trigger	K1S Rocker Style-Black*	P9 Button #1 Color	P9 Button #2 Color	P9 Button #3 Color	P9 Button #4 Color	P9 Button #4 Color
1. Grip with Adaptor 2. Grip without Adaptor	See Switch Configuration on next page	1. None 2. Yes	1. None 2. ON-OFF 3. (ON)-OFF 4. ON-OFF-ON 5. (ON)-OFF-(ON) 6. ON-ON-ON	1. Red 2. Black 3. Orange 4. Yellow 5. Green 6. Blue 7. Violet 8. Gray 9. White N. None	1. Red 2. Black 3. Orange 4. Yellow 5. Green 6. Blue 7. Violet 8. Gray 9. White N. None	1. Red 2. Black 3. Orange 4. Yellow 5. Green 6. Blue 7. Violet 8. Gray 9. White N. None	1. Red 2. Black 3. Orange 4. Yellow 5. Green 6. Blue 7. Violet 8. Gray 9. White N. None	1. Red 2. Black 3. Orange 4. Yellow 5. Green 6. Blue 7. Violet 8. Gray 9. White N. None

\* ( ) Denotes Momentary Action. ON Position or Momentary Position is up or to the right.



**ALDERS**  
Indicate. Control. Connect.

ALDERS electronic GmbH  
Arnoldstraße 19  
47906 Kempen - Allemagne

+33 3 88064677  
+33 6 33389393  
catherine.sturm@alders.fr / www.alders.fr

Votre distributeur officiel

## MEDIUM SIZE ERGONOMIC GRIP

### SWITCH CONFIGURATIONS

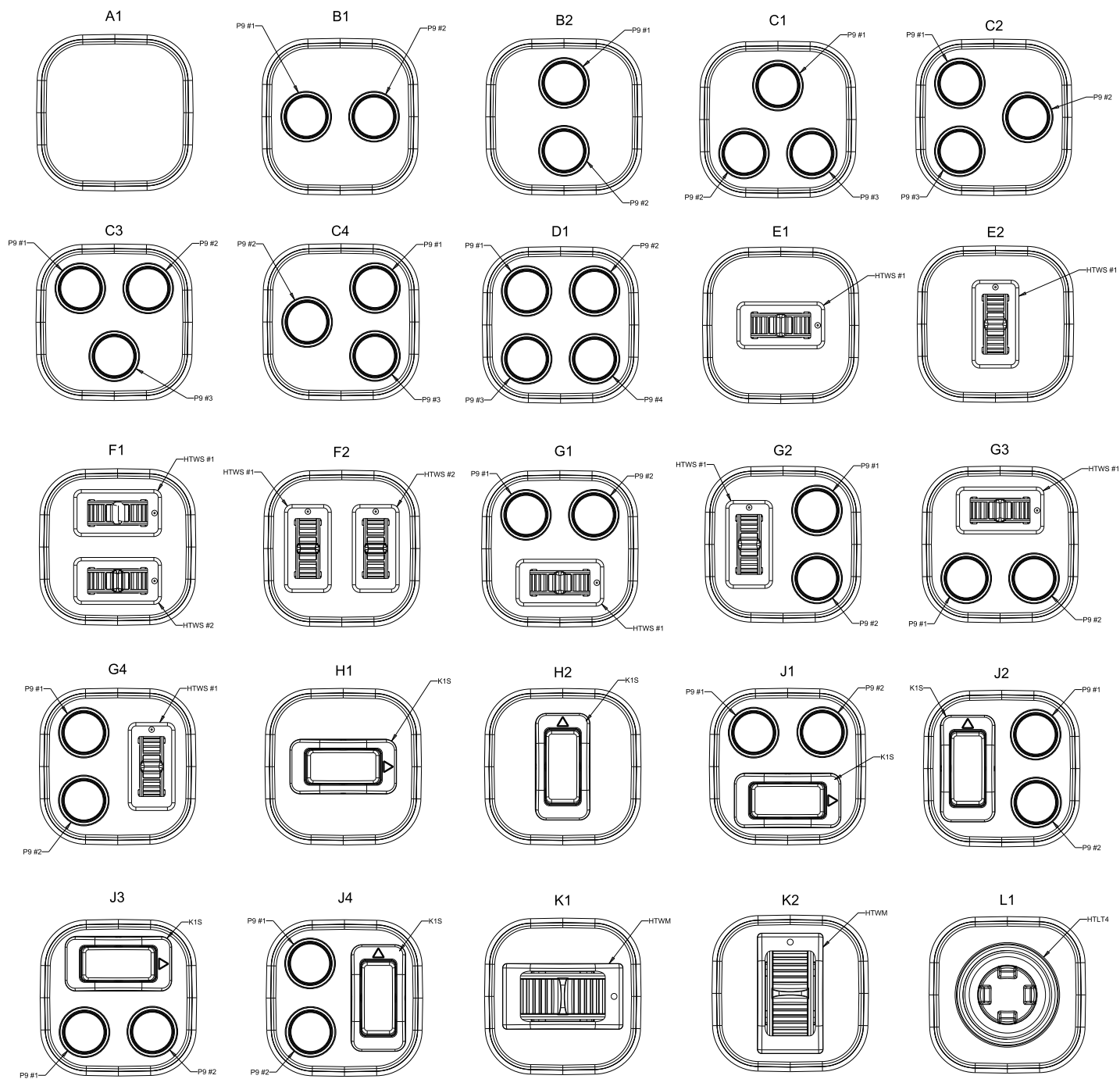

MEDIUM SIZE ERGONOMIC GRIP

## G3-M SCHEMATICS

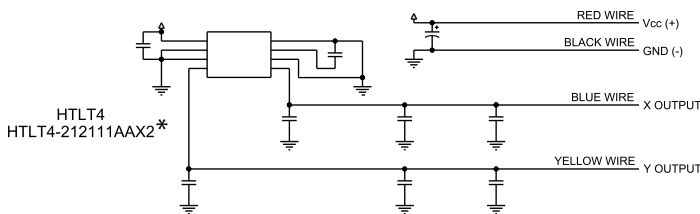
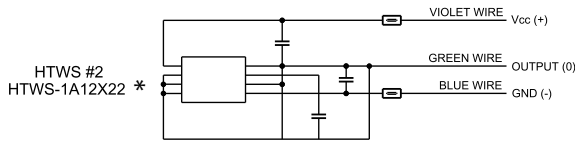
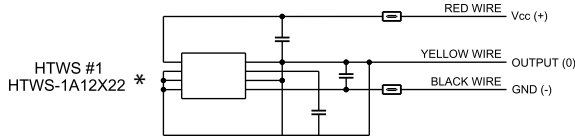
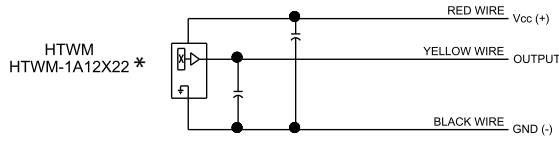

\*POSITIVE TRAVEL IS UP OR TO THE RIGHT. CONTACT FACTORY FOR ADDITIONAL OPTIONS.

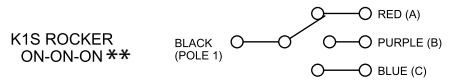
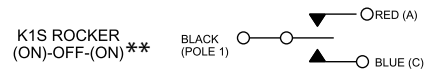
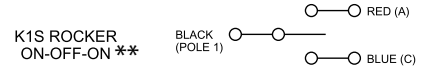
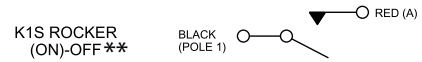
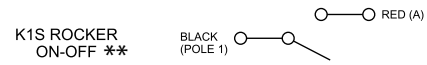
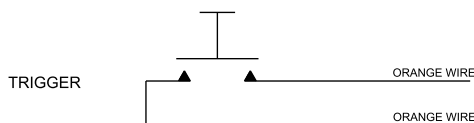
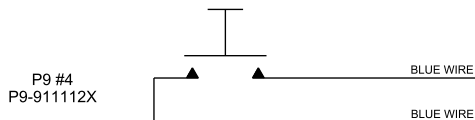
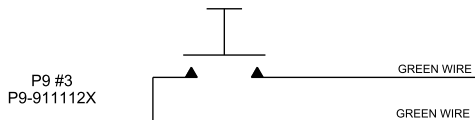
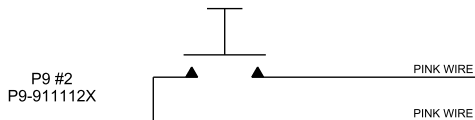
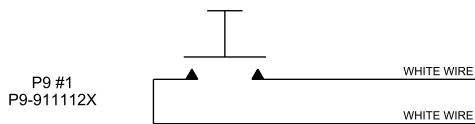

\*\*ON POSITION OR MOMENTARY POSITION IS UP OR TO THE RIGHT.

HTWM & HTWS OUTPUT

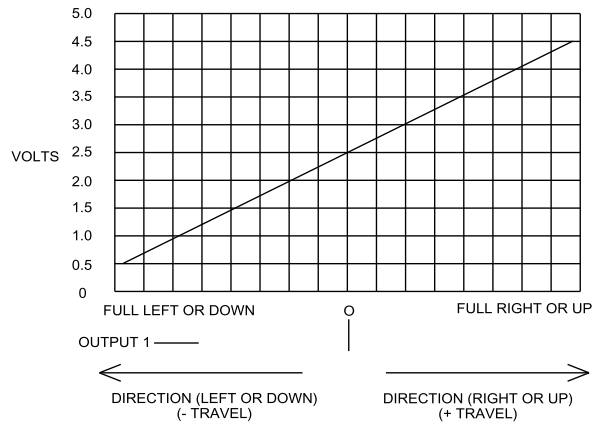

HRTL4 OUTPUT

