

CANBUS-ENABLED, SEALED OPERATOR CONTROL MODULE FOR HEAVY DUTY EQUIPMENT

The CAN Rocker is a CANbus technology-enabled, programmable operator control module. The watertight module is ideal for panels and armrests in off-road/heavy equipment and vehicles.

The CAN Rocker has three switches, each of which features two RGB LEDs to denote functions, such as cab temperature and vehicle speed. Use CAN messages to select nearly any LED color or brightness and to program buttons for two- or three-position, momentary or maintained action. Customers can snap in alternative buttons and reprogram switches in the field.

Features:

- Snap-in design for easy installation and button changes
- Programmable LEDs with variable intensity color and synchronized or individual flashing
- Standard and customizable icons
- Customer-configurable operating parameters
- Choose two- or three-switch position and momentary or maintained function for each rocker position
- Supports up to seven modules using a secondary CAN expansion bus connection
- Built-in Deutsch® connection
- 9-32VDC voltage input
- Sealed to IP65
- Withstands -40°C to +85°C operating temperatures
- Buttons available in black, red, yellow or orange



Standard Characteristics/Ratings:	
ELECTRICAL RATINGS:	
Supply Voltage:	9-32 VDC
Electrical Life:	1,000,000 cycles
MECHANICAL:	
Mechanical Life:	1,000,000 cycles
Enclosure Design:	ISO 20653, IP65-Dusttight, Water Jets (Electronics Only)
Temperature Range:	-40° C to +85° C
PHYSICAL:	
Base Material:	Black Thermoplastic
Button Material:	Black Painted Thermoplastic, Laser Etched Graphics
Illumination:	Programmable RGB LED for each individual graphic
Bezel Material:	Black Thermoplastic
Connector:	Compatible with DT06-6S

CMK ROCKER DRAWINGS

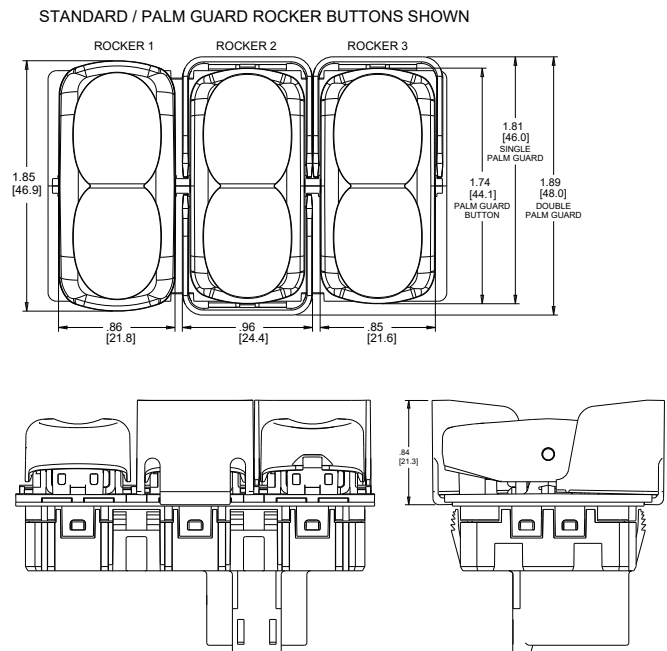
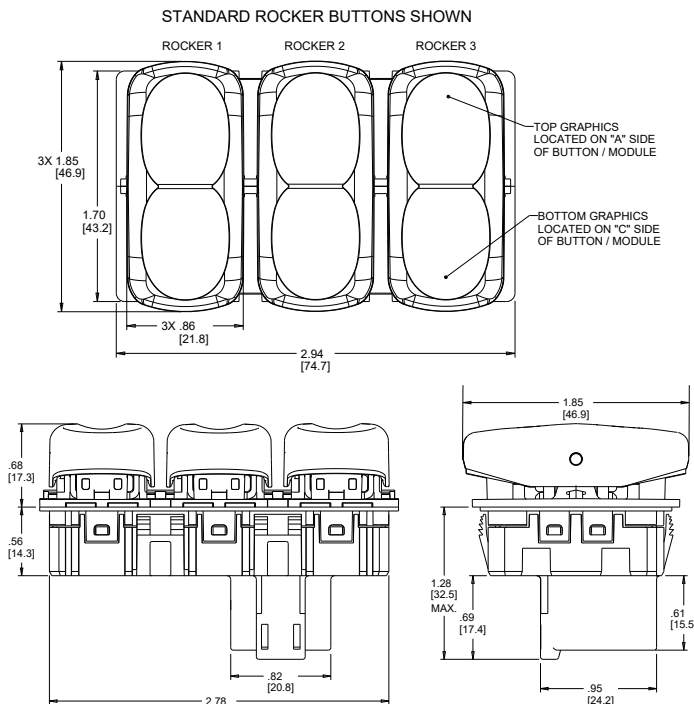

CAN ROCKER MODULE

CANBUS-ENABLED, SEALED OPERATOR CONTROL MODULE FOR HEAVY DUTY EQUIPMENT

CMK PART NUMBER CODE

Part Number Code Continues Below

CMK XX	-	X	X	X	XX	XX																																
Configuration		Rocker 1 Button Color	Rocker 1 Button	Rocker 1 Switch Action*	Rocker 1 Graphic Style(s)																																	
BA. Base Module B1. Base w/Expansion E1 B2. Base w/Expansion E1, E2 B3. Base w/Expansion E1, E2, E3 B4. Base w/Expansion E1, E2, E3, E4 B5. Base w/Expansion E1, E2, E3, E4, E5 B6. Base w/Expansion E1, E2, E3, E4, E5, E6 B7. Base w/Expansion E1, E2, E3, E4, E5, E6, E7 E1. Expansion 1 E2. Expansion 2 E3. Expansion 3 E4. Expansion 4 E5. Expansion 5 E6. Expansion 6 E7. Expansion 7		A. Black B. Orange C. Red D. Yellow	A. Standard B. Palm Guard, A Side C. Palm Guard, C Side & C Side D. Palm Guard, A Side & C Side	<table border="0"> <thead> <tr> <th>Position "A"</th> <th>Position "B"</th> <th>Position "C"</th> <th>Action</th> </tr> </thead> <tbody> <tr><td>A. M</td><td>M</td><td>M</td><td>Full 3 Position</td></tr> <tr><td>B. (M)</td><td>M</td><td>(M)</td><td>Full 3 Position</td></tr> <tr><td>C. (M)</td><td>M</td><td>M</td><td>Full 3 Position</td></tr> <tr><td>D. M</td><td>None</td><td>M</td><td>Full 2 Position</td></tr> <tr><td>E. (M)</td><td>None</td><td>M</td><td>Full 2 Position</td></tr> <tr><td>G. M</td><td>M</td><td>(M)</td><td>Full 3 Position</td></tr> <tr><td>H. M</td><td>None</td><td>(M)</td><td>Full 2 Position</td></tr> </tbody> </table>	Position "A"	Position "B"	Position "C"	Action	A. M	M	M	Full 3 Position	B. (M)	M	(M)	Full 3 Position	C. (M)	M	M	Full 3 Position	D. M	None	M	Full 2 Position	E. (M)	None	M	Full 2 Position	G. M	M	(M)	Full 3 Position	H. M	None	(M)	Full 2 Position	ZZ. No Graphic ZZ. No Graphic	NOTE: For all Legend Options, refer to Standard Legend Table. Find the two digit code and enter the code in the appropriate positions. Contact factory for all other custom options.
Position "A"	Position "B"	Position "C"	Action																																			
A. M	M	M	Full 3 Position																																			
B. (M)	M	(M)	Full 3 Position																																			
C. (M)	M	M	Full 3 Position																																			
D. M	None	M	Full 2 Position																																			
E. (M)	None	M	Full 2 Position																																			
G. M	M	(M)	Full 3 Position																																			
H. M	None	(M)	Full 2 Position																																			

* (M) denotes momentary action.
M denotes maintained action.

Part Number Code Continued: Rocker 2	-	X	X	X	XX	XX																																
		Rocker 2 Button Color	Rocker 2 Button	Rocker 2 Switch Action	Rocker 2 Graphic Style(s)																																	
		A. Black B. Orange C. Red D. Yellow	A. Standard B. Palm Guard, A Side C. Palm Guard, C Side & C Side D. Palm Guard, A Side & C Side	<table border="0"> <thead> <tr> <th>Position "A"</th> <th>Position "B"</th> <th>Position "C"</th> <th>Action</th> </tr> </thead> <tbody> <tr><td>A. M</td><td>M</td><td>M</td><td>Full 3 Position</td></tr> <tr><td>B. (M)</td><td>M</td><td>(M)</td><td>Full 3 Position</td></tr> <tr><td>C. (M)</td><td>M</td><td>M</td><td>Full 3 Position</td></tr> <tr><td>D. M</td><td>None</td><td>M</td><td>Full 2 Position</td></tr> <tr><td>E. (M)</td><td>None</td><td>M</td><td>Full 2 Position</td></tr> <tr><td>G. M</td><td>M</td><td>(M)</td><td>Full 3 Position</td></tr> <tr><td>H. M</td><td>None</td><td>(M)</td><td>Full 2 Position</td></tr> </tbody> </table>	Position "A"	Position "B"	Position "C"	Action	A. M	M	M	Full 3 Position	B. (M)	M	(M)	Full 3 Position	C. (M)	M	M	Full 3 Position	D. M	None	M	Full 2 Position	E. (M)	None	M	Full 2 Position	G. M	M	(M)	Full 3 Position	H. M	None	(M)	Full 2 Position	ZZ. No Graphic ZZ. No Graphic	NOTE: For all Legend Options, refer to Standard Legend Table. Find the two digit code and enter the code in the appropriate positions. Contact factory for all other custom options.
Position "A"	Position "B"	Position "C"	Action																																			
A. M	M	M	Full 3 Position																																			
B. (M)	M	(M)	Full 3 Position																																			
C. (M)	M	M	Full 3 Position																																			
D. M	None	M	Full 2 Position																																			
E. (M)	None	M	Full 2 Position																																			
G. M	M	(M)	Full 3 Position																																			
H. M	None	(M)	Full 2 Position																																			

* (M) denotes momentary action.
M denotes maintained action.

Part Number Code Continued: Rocker 3	-	X	X	X	XX	XX																																
		Rocker 3 Button Color	Rocker 3 Button	Rocker 3 Switch Action*	Rocker 3 Graphic Style(s)																																	
		A. Black B. Orange C. Red D. Yellow	A. Standard B. Palm Guard, A Side C. Palm Guard, C Side & C Side D. Palm Guard, A Side & C Side	<table border="0"> <thead> <tr> <th>Position "A"</th> <th>Position "B"</th> <th>Position "C"</th> <th>Action</th> </tr> </thead> <tbody> <tr><td>A. M</td><td>M</td><td>(M)</td><td>Full 3 Position</td></tr> <tr><td>B. (M)</td><td>M</td><td>(M)</td><td>Full 3 Position</td></tr> <tr><td>C. (M)</td><td>M</td><td>M</td><td>Full 3 Position</td></tr> <tr><td>D. M</td><td>None</td><td>M</td><td>Full 2 Position</td></tr> <tr><td>E. (M)</td><td>None</td><td>M</td><td>Full 2 Position</td></tr> <tr><td>G. M</td><td>M</td><td>(M)</td><td>Full 3 Position</td></tr> <tr><td>H. M</td><td>None</td><td>(M)</td><td>Full 2 Position</td></tr> </tbody> </table>	Position "A"	Position "B"	Position "C"	Action	A. M	M	(M)	Full 3 Position	B. (M)	M	(M)	Full 3 Position	C. (M)	M	M	Full 3 Position	D. M	None	M	Full 2 Position	E. (M)	None	M	Full 2 Position	G. M	M	(M)	Full 3 Position	H. M	None	(M)	Full 2 Position	ZZ. No Graphic ZZ. No Graphic	NOTE: For all Legend Options, refer to Standard Legend Table. Find the two digit code and enter the code in the appropriate positions. Contact factory for all other custom options.
Position "A"	Position "B"	Position "C"	Action																																			
A. M	M	(M)	Full 3 Position																																			
B. (M)	M	(M)	Full 3 Position																																			
C. (M)	M	M	Full 3 Position																																			
D. M	None	M	Full 2 Position																																			
E. (M)	None	M	Full 2 Position																																			
G. M	M	(M)	Full 3 Position																																			
H. M	None	(M)	Full 2 Position																																			

* (M) denotes momentary action.
M denotes maintained action.

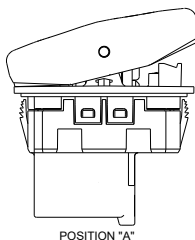

POSITION "A"

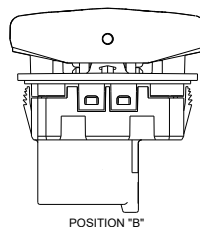

POSITION "B"

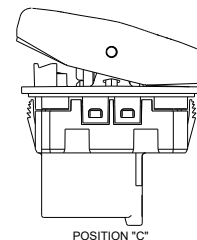

POSITION "C"

MAINTAINED - MAINTAINED - MAINTAINED
ROCKER CONFIGURATION OPTION SHOWN

CANBUS-ENABLED, SEALED OPERATOR CONTROL MODULE FOR HEAVY DUTY EQUIPMENT

The standard CAN Rocker ships with a default configuration with pre-specified communications parameters unless indicated otherwise. These are the summarized CANopen parameters for the default configuration spelled out in the User Manual (OTTO P/N: 804487-1):

Node ID = 127

Baud rate = 250Kb

Rocker module Receive PDO for LEDs

- COB-ID = 0x27F
- Data: See 7.2 LED WRITE 4 BYTE DATA J1939 AND CANOPEN

Rocker module Transmit PDO switch contact data:

- COB-ID = 0x1FF (change event only)
- Data: See 7.1 SWITCH CONTACT READ 2-BIT DATA
 - Byte 1: Base module STATUS0
 - Byte 2: Base module STATUS1
 - Byte 3: Base module STATUS2

Expansion modules are disabled

- Error messages will be transmitted if expansion modules are enabled but are not connected.

Votre distributeur officiel



ALDERS®
Indicate. Control. Connect.

ALDERS electronic GmbH
Arnoldstraße 19
47906 Kempen - Allemagne

+33 3 88064677
+33 6 33389393
catherine.sturm@alders.fr / www.alders.fr

Custom order: The CAN Rocker module may be ordered pre-configured to customer parameters to drop into a customer CAN network. In these cases, OTTO will establish a customer-specific part number tailored for every instance of a CAN Keypad module used. Consult with an OTTO salesperson for more information. Refer to User Manual (OTTO P/N: 804487-1).

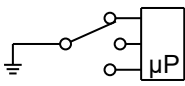
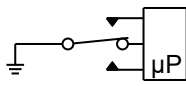
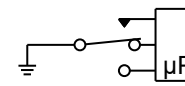
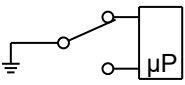
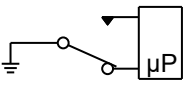
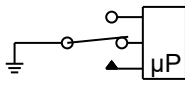
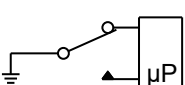
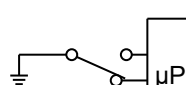
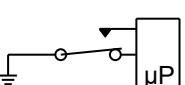
CIRCUIT DIAGRAMS AVAILABLE FOR INDIVIDUAL ROCKERS		
3 POSITION	3 POSITION	3 POSITION
 M-M-M SPDT - SCHEMATIC	 (M)-M-(M) SPDT - SCHEMATIC	 (M)-M-M SPDT - SCHEMATIC
2 POSITION	2 POSITION	3 POSITION
 M-NONE-M SPDT - SCHEMATIC	 (M)-NONE-M SPST - SCHEMATIC	 M-M-(M) SPDT - SCHEMATIC
2 POSITION	HALF ACTION	HALF ACTION
 M-NONE-(M) SPST - SCHEMATIC	 M-M-NONE OR NONE-M-M SPST - SCHEMATIC	 (M)-M-NONE OR NONE-M-(M) SPST - SCHEMATIC
GENERAL SCHEMATIC INFORMATION		
<p>○ — INDICATES MAINTAIN ACTION (FIXED POSITION)</p> <p>▼ — INDICATES MOMENTARY ACTION (AUTOMATIC RETURN POSITION)</p>		

CAN ROCKER MODULE

CANBUS-ENABLED, SEALED OPERATOR CONTROL MODULE FOR HEAVY DUTY EQUIPMENT

WIRING DIAGRAM - UNSHIELDED TWISTED PAIR

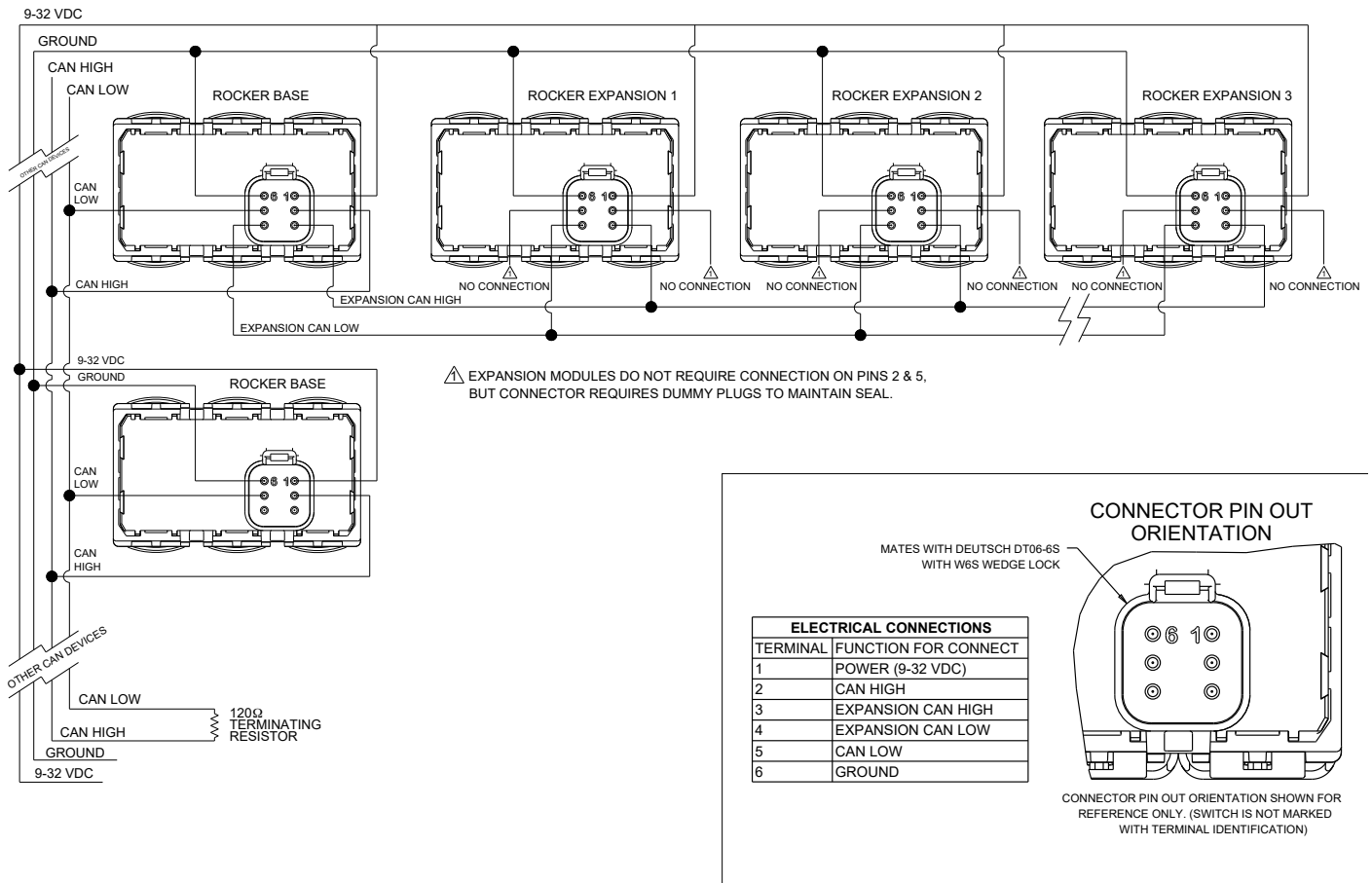

STANDARD PANEL CUTOUT

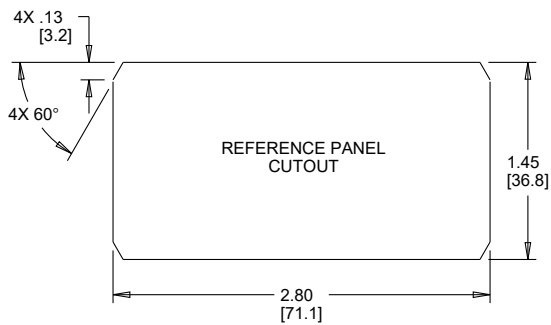

PANEL THICKNESS AND MOUNTING OPENING GUIDELINES:
 INTEGRATED PANEL GASKET
 RECOMMENDED PANEL THICKNESS: .06 - .12 [.50-3.00 MM]

OPTIONAL PANEL OPENING FEATURES

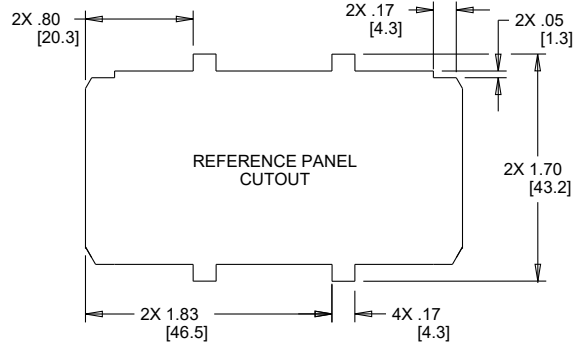

FRONT PANEL REMOVABLE SLOTS FOR SERVICING
 FROM THE FRONT PANEL WITHOUT FURTHER DISASSEMBLY